

VIMAR

Ecological Boilers VIGAS

MANUAL FOR INSTALLATION, ASSEMBLY AND USE

VIGAS and VIGAS Lambda Control
with **AK 3000**

Certificate of warranty



Content	Page
Declaration of conformity.....	3
1. Technical description.....	4
2. Technical data.....	5
3. Description of AK 3000 control.....	7
4. VIGAS boiler in basic configuration.....	9
5. VIGAS boiler in configuration with gases thermometer.....	11
6. VIGAS boiler in configuration with gases thermometer and discharge fan.....	12
7. VIGAS <small>Lambda Control</small> in configuration with gases thermometer.....	13
8. VIGAS <small>Lambda Control</small> in configuration with gases thermometer and discharge fan.....	15
9. Time setting.....	17
10. Hardware and software information.....	18
11. Error messages.....	18
12. Service settings PIN 0000 protected.....	18
13. Operating instructions.....	21
14. Boiler maintainance and repairs.....	24
15. Accesories assembly.....	26
16. Listo fo guarantee and afterguarantee services.....	28
17. Problems solving.....	28
18. Assembly instruction.....	29
19. Electric scheme of connection VIGAS boilers.....	31
Letter of guarantee.....	32
Confirmation of VIGAS boilers commissioning.....	33



DECLARATION OF CONFORMITY
Issued according to Section 12, par. 3, letter a) Act No. 264/1999 Coll.
and 97 / 23 EC

We, VIMAR Vigaš Pavel

M. Čulena 25
974 11 Banská Bystrica
SLOVAKIA
IČ DPH: SK 1020548001

hereby declare that the undermentioned products comply with technical regulations and the products are safe if determined conditions are followed and we took all possible measures to assure the compliance of products with technical documentations as well as with relevant instructions requirements of government.

Product: Thermal boiler VIGAS and VIGAS Lambda Control **with AK 3000 control**

Type: VIGAS 16, VIGAS 16 Lambda Control
VIGAS 25, VIGAS 25 Lambda Control
VIGAS 40, VIGAS 40 Lambda Control
VIGAS 60, VIGAS 60 Lambda Control
VIGAS 80, VIGAS 80 Lambda Control
VIGAS 100, VIGAS 100 Lambda Control
VIGAS 29 UD

Producer: VIMAR Vigaš Pavel
M. Čulena 25, 974 11 Banská Bystrica,
SLOVENSKO

The above-mentioned products comply with the following standards:
STN 07 7401, STN 73 4210, STN EN 303-5, STN EN 61000-3-
2:2000+A1:2001+A2:2001, STN EN 61000-3-3:2000.

Supplementary data: Certificates, Test report

Issued in: Banská Bystrica

Name: VIGAŠ Pavel

Date of issue:

Title: Owner

Signature:

1. TECHNICAL DESCRIPTION

Thermal boilers VIGAS are designed for combustion of dry wood material, starting from sawdust up to logs in the length according to the dimensions of gasification chamber, maximum 20 cm. Sawdust, chippings, splinters and cuttings must be burn together with logs. Thermal boiler, VIGAS UD 29 is designed for burning brown coal. It is also possible to use dry wooden material as a substitute fuel.

Boilers are welded from 4- 6 mm steel sheets. Inner boiler sheets that have contact with boiler waste gases are 6 mm thick, others are made of 4 mm sheet. Heat exchanger is welded from steel pipes, 57x 5 mm. Exterior boiler shell is made of 0.8 mm sheet. Thermal insulation of the boiler is made of insulation material, NOBASIL, 20 and 50 mm thick. Boiler waste gases go away through steel neck to chimney.

Inner boiler space consists of gasification chamber, where fuel is dried and gasified. Then created gas goes through fireproof /concrete/ nozzle into combustion chamber, where it burns with the help of secondary air. Boiler waste gasses are intensively cooled in exchanger. Wood that is not burnt must be removed from combustion chamber. The boiler has a lighting up damper that is controled by operating rod at the front part of boiler.

In order the boiler complies with the requirements for non-demanding operation, it is equipped with AK 3000 control unit that is situated in the upper part of boiler. The used system of control allows very effective combustion of various kinds of fuel. AK 3000 control with graphical display, in basic configuration allows:

- to control temperature of heated water in range 60 ÷ 85 °C
- smooth and automatic control of forced draft fan according to required output and
- to connect discharge fan
- to connect circulation pump
- to connect gases thermometer
- to connect and to control boiler by space temperature regulator
- to connect extended regulation (EXPANDER) via AK BUS
- to connect module with Ethernet interface and SD-card for data saving and consecutive evaluation via PC
- graphical scheme indication of hydraulic connection as requested
- real time set

In configuration VIGAS Lambda Control also allows :

- Utilizes informations from lambda sensor of oxygen overflow in gases, to control the chimney flap of primary and secondary air.
- Gases thermometer as a standard

Boilers are equiped with thermal fuse that ensures disconnection of forced draft fan if boiler is overheated above 100 °C and safety exchanger against overheating according to the standard, STN EN 303/5. Its recommended, by producer, to buy a release valve Honeywell TS 130 3/4" for safety exchanger against over heating.

2. Technical data									Tab.1
THERMAL BOILERS									
VIGAS		16	25	40	60	80	100	UD 29	
Nominal boiler output	kW	16	25	40	60	80	100	29	
Boiler class according to EN 303-5		3							
Max. operating pressure	bar	3							
Fuel		Wood, max. moisture 20% ;heating min. 15 MJ/kg						Brown coal	
Output capacity	kW	12 - 18	5 - 31	8 - 41	15 - 72	25 - 92	25-100	8-35(8-29)*	
Fuel consumption with nominal output	kg/hod	4,5	7,6	11,2	19	25	30,4	7,8 (8,0)*	
Substitute fuel		Wood waste, splinters, saw dust, saw dust briquettes (for UD 29 also wood of max. moisture 20%)							
Chimney daught	mBar	0,20 – 0,25		0,20 – 0,35		0,30 – 0,40		0,20 – 0,25	
Weight	kg	400	430	460	760	930	950	430	
Height with regulation	A mm	1135	1135	1385	1420			1120	
Height of exhaust branch	B mm	975	1045	1310	1400			1045	
Height of inlet branch	C mm	115		125	215			110	
Height of feed-water valve	D mm	55	60	70	135			55	
Height of chimney neck	E mm	890		1110	1170			890	
Width including rod	F mm	645			785			645	
Width including shell	G mm	590			760			590	
Depth	H mm	840	1070		1260	1650		1070	
Exhaust brand	I mm	240			520			240	
Diameter od draught neck	J mm	160		200				160	
Dimmension from edge of boiler	K mm	188	305		880	1210		230	
Spacing of feed pipes	L mm	405			70			350	
Diameter of inlet brand	G/mm	2"							
Diameter of exhaust brand	G/mm	2"							
Diameter of feed-water valve	G	1/2"			3/4"			1/2"	
Volume of water	l		75	93	180	205	215	75	
Gases temperature	°C	240							
With nominal output	°C	150							
With minimal output									
Dimensions of gasification chamber	mm	370	560		750	1150	1090	490/440	
Depth									
Height	mm	490		750	730			500	
Width	mm	440			575			440	
Dimensions of gasification chamber (width-height)	mm	435 -255			575 – 318			435 - 255	
Max. weight of fuel	kg	20	30	40	80	150		30	
Capacity of gasification chamber	dm ³	80	120	185	315	483	457	105	
Noisness	dB	45	45,5	47,7	51,4	54,2		45,5	
Max. electric input	W	70			140			70	
Voltage/Frequency	V/Hz	230ACV / 50 Hz							
Pressure loss of water :									
Δt 10 °C	mBar	9,70	9,75	10,48	12,77	11,83	11,53	9,97	
Δt 20 °C	mBar	1,00	1,05	2,55	3,19	2,96	2,84	1,15	
Time of burning with nominal output	hod	4,5	4,20	4,30	4,20	4,20	4,0	5,60 (4,10)	
Cooling exchanger of heat - temperature of inlet water	°C	4 – 15							
- pressure of inlet water	bar	min 1 – max 4							
Safety		Release valve Honeywell TS 130 3/4" for safety exchanger against over heating, Opening temperature 95°C							
		STB fuse, blow temperature 100°C (tolerance: -6°C -- 0°C)							
Weight flow of gases	kg/s	0,034 – 0,047							

* specification for wood fuel

2.1 DIMENSION CHART AND THE POSITION OF PROTECTIVE SUPPORT PLATE ON EASILY IGNITABLE FLOOR

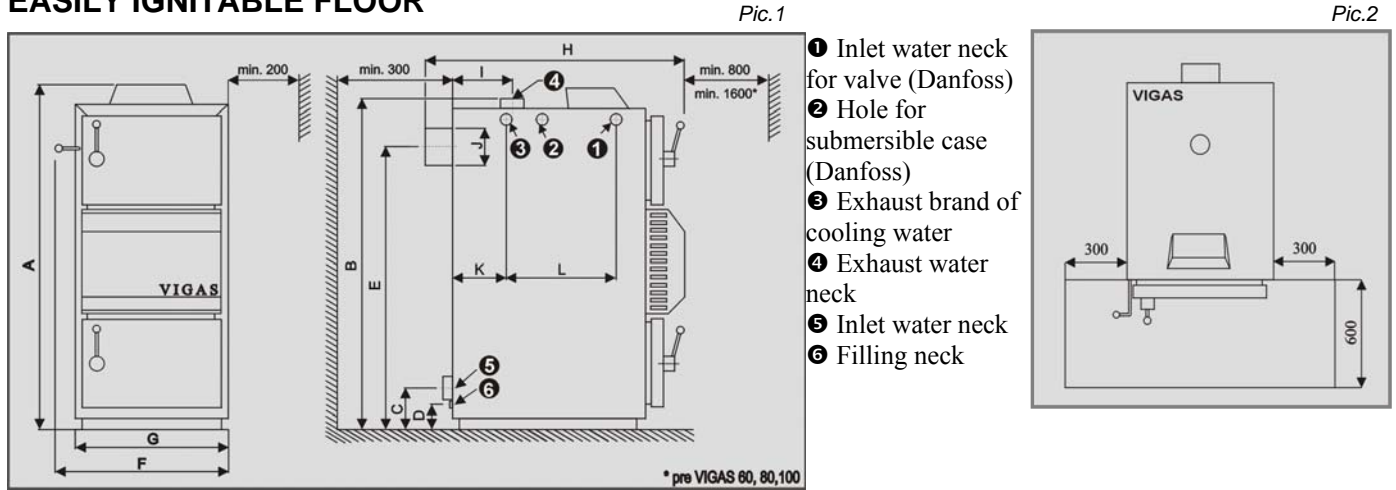

2.2 BOILER SCHEMATICS

Scheme VIGAS 16

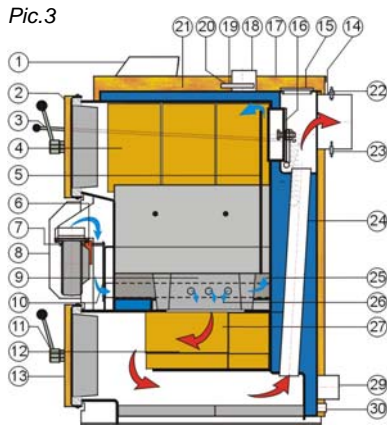

Scheme VIGAS 25

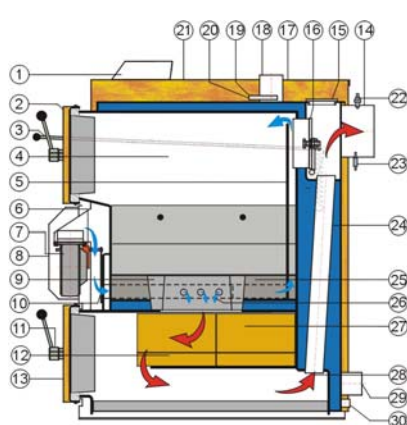

Scheme VIGAS 40

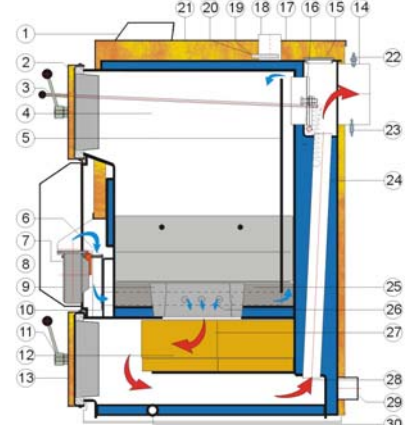

Scheme VIGAS 29 UD

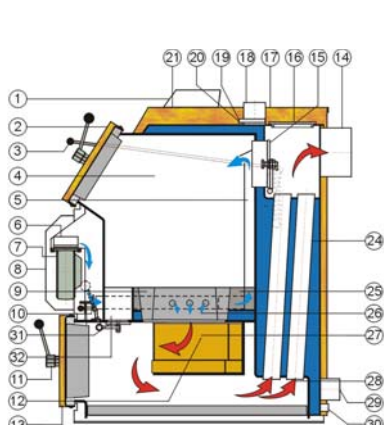

Scheme VIGAS 60,80

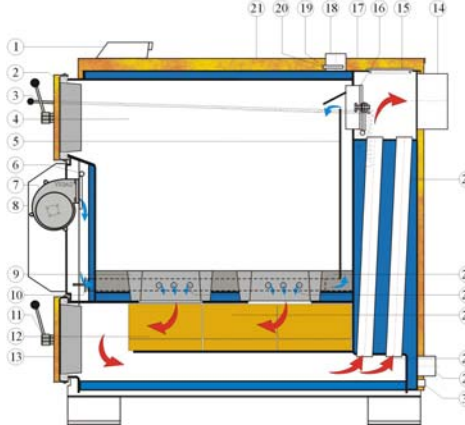

Scheme VIGAS 100

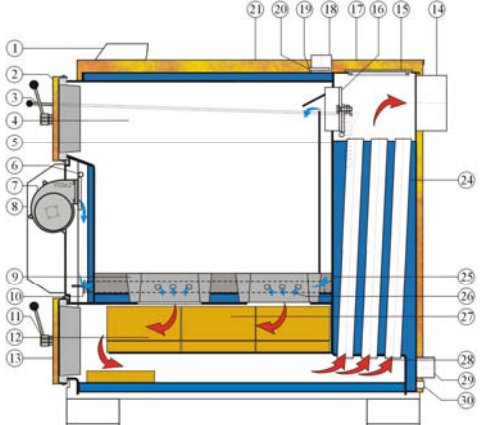

KEY		
1. AK 3000 control	11. Door closing device	22. Lambda sensor
2. Upper door	12. Fireclay bricks	23. Gases thermometer
3. Chimney flap operating rod	13. Bottom door	24. Exchanger pipes
4. Fuel bunker	14. Chimney neck	25. Heat proof /concrete/ filling
5. Primary air conduction	15. Exchanger cap	26. Secondary air
6. Flap for Lambda control servo	16. Lighting up damper	27. Combustion chamber
7. Fan	17. Upper back cover	28. Direction of gases
8. Fan cover	18. Outlet water neck	29. Neck of reversible water
9. Heatproof nozzle	19. Thermal fuse	30. Filling neck
10. Secondary air screen	20. Thermometer	31. Cleaning flap for 29UD
	21. Upper front cover	32. Cleaning hole for 29UD

3. DESCRIPTION OF AK 3000 CONTROL

3.1 Safety Instructions

- Check protection (cover) metal sheet before plug-in the power wire
- Avoid any contact of power wire with hot parts of the boiler (f.e. chimney)
- Make sure, no water is allowed under the upper isolation (risk of short circuit)
- Do not stress the power wire
- Always disconnect the power wire when a new electrical components are connecting (f.e. indoor thermostat, discharge fan or circulation pump)
- Do not remove protection (cover) metal sheet during the boiler operation, especially from fan
- Compare working voltage displayed on the label with your distribution network
- Always observe safety regulations

3.2 Connecting to the distributing network

AK 3000 control is integral part of VIGAS boilers.

Control is connected when power wire is plugged in to the distributing network 220/230V. Display is active when power wire is plugged-in (Pic.4). Servo-flat used in VIGAS *Lambda Control* is set to base position (Pic.5).

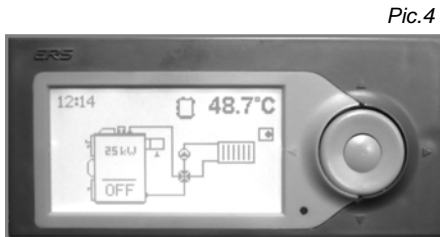

Pic.4



Pic.5

3.3 Working conditions

Operation temperature range of AK 3000 control is +5°C to +45 °C. Control may not be used in humid environment or direct sunlight.

3.4 Maintenance of AK 3000 control

Keep in clean and dust-free environment. Antistatic, or wet wiper is advised to wipe-off dust and impurities from metal cover and control panel.

3.5 Control panel

Part of the electronic control is panel, equipped with buttons, pictograms and display. Further informations will be available in the next part of this manual.

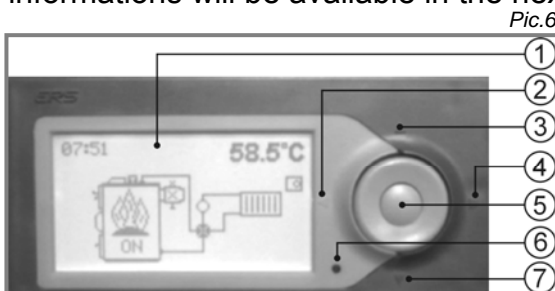

Pic.6

1. Graphical display 128 x 64 pixels
2. Button ◀ with functions
3. Button ▲ with functions
4. Button ▶ with functions
5. Button ● (ENTER) with functions
6. LED control
7. Button ▼ with functions

Functionality of each button are composite and their functionality depends accompanying description on display and from manufacture settings.

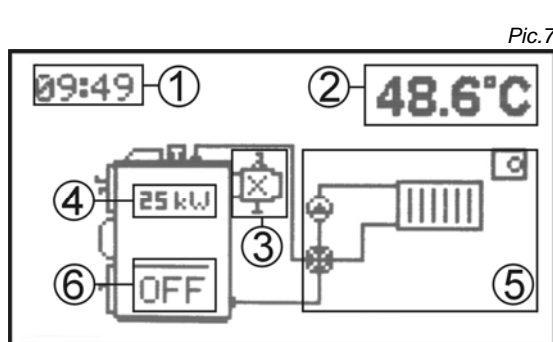

1. Real time indication.
2. Indication of current boiler values.
Modification ▲ or ▼.
3. Indication of discharge fan, lambda sensor, gases thermometer
4. Indication of nominal boiler output when switched off.
5. Graphically indicated hydraulic scheme of connection.
6. Indication of boiler status.

3.6 Symbols

Boiler		Storage tank		External boiler	
Boiler „ON“	ON	DUOMIX		Heating circuit	
Boiler „OFF“	OFF	DUOMIX with servomotor		Indoor thermostat	
Heating	 ON	Pump		3-way thermostatic valve	
Burning	 73°C	Discharge fan		LADOMAT	
Afterflaming	 52°C	Lambda	λ	Fan	
End of burning	END	Thermometer	T	Fan change output	
Indoor thermostat decay		Error indication value	X	Open flap	servo 50%
Adding fuel		Minimal value of gases	min	Maximal value of gases	max
Temperature settings		Parameter settings		Time setting	
Error messages		Program		Konfiguration informations	
Service message					

4. VIGAS BOILER IN BASIC CONFIGURATION

(without discharge fan, gases thermometer and lambda sensor)

4.1 VIGAS BOILER OPERATING

4.1.1 Boiler activation

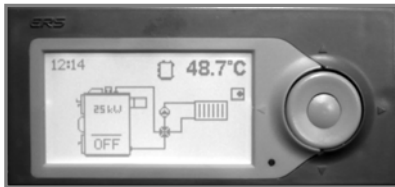

If boiler is in unactive status with symbol „OFF“, as displayed on the picture, by pressing the central button ENTER the boiler start the operation.

4.1.2 Boiler activated – heating mode

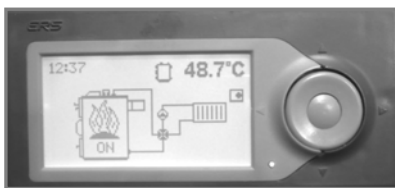

Boiler is set to heating mode, if temperature of outgoing water is lower, then set shutdown temperature of the boiler. Shutdown temperature is in settings. Usually is set to 50°C. Pump is **pulse** working in dependence on temperature of the boiler water! The pump is working, when symbol flash.

4.1.3 Boiler activated – burning mode

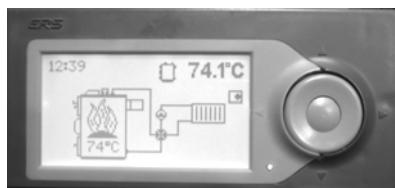

The burning mode is active after the shutdown temperature is higher + time deviation. In this mode pump is working **pulse** (bolier protection against low-temperature corrosion), 5°C before set temperature constantly. The pump is working, when symbol flash. Boiler is responsive to indoor thermostat, when indoor thermostat is switched off boiler slowly decreasing its output.

4.1.4 Adding fuel, Disconnection the boiler (manually)

Using graphical control. To call the graphical control, press central button ENTER. Graphical control offers option to switch off, adding fuel or cancel the graphical control.



Choose one option	
OFF	Switch-off
	Add fuel
<input checked="" type="checkbox"/>	Cancel the control
▼▲	Change the indicated value

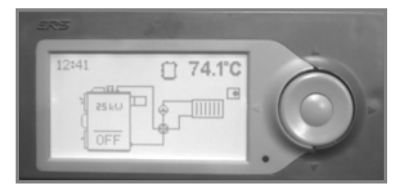

By pressing „“ fan will be switched off. By using the rod open the chimney flap, consequently open the upper door. You can add fuel, if necessary. Close the upper door and chimney flap.



By pressing „“ adding fuel will be stopped. Fan will be switched-on automatically.

4.1.5 Disconnection the boiler (Automatically)

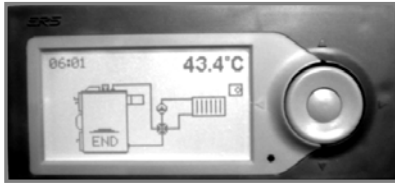

When temperature drops under the shutdown temperature (see Parameter settings of Vigas boiler in basic configuration) boiler is switch-off automatically. „END“ will be indicated on the display. By pressing „ENTER“ boiler will start operating again.

4.2 TEMPERATURE SETTINGS OF OUTLET WATER

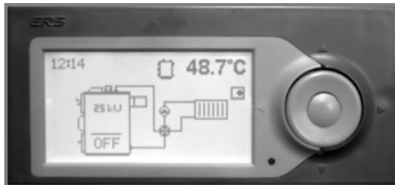

To call temperature setting hold „ENTER“ button at any boiler status. Symbol of the temperature setting will be indicated on the display. Press „ENTER“ again. Symbol of the nominal output will be indicated on the display with value, together with temperature of outlet water in °C. By pressing the „ENTER“ button, the value start to flash.



„ENTER“



„ENTER“

Temperature is flashing, by using buttons ▲▼ choose requested value. Button ► will exit the temperature settings.

4.3 PARAMETERS SETTING OF VIGAS BOILER

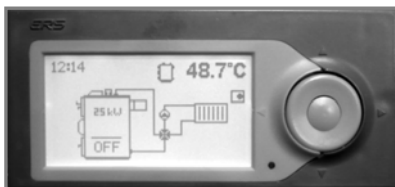

To call parameters setting hold „ENTER“ button at any boiler status and by pressing ▲ button. Press „ENTER“ again Symbol of the parameters setting will be indicated on the display. By pressing the „ENTER“ button twice, the values you can set will be indicated on the display.



„ENTER“

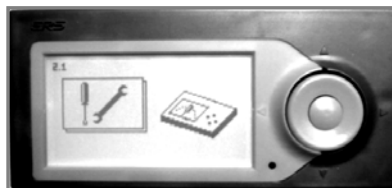

„ENTER“



By ▲▼ buttons set the parameter you want to edit and by pressing „ENTER“ button, the value starts to flash. ▲▼ buttons set requested value.

end	Choose shutdown temperature of the boiler
„△⊙“	Increase or decrease the value, maximal output will be changed. Is advised to decrease the value in transition period (boiler tar level will drop).
*	Brightness
Roll	Press „yes“ will activate the value rolling (Pic.6/2)
Help 0s	Set the time when graphical control will be indicated

5. VIGAS BOILER IN CONFIGURATION WITH GASES THERMOMETER

(without discharge fan and lambda sensor)

The advantage of the gases thermometer is elimination of the maximal gases temperature, if it will be reached, it will effect the speed drop of fan. As consequence will be increased efficiency followed by low fuel consumption. In configuration with storage tank, its used for boiler to shutdown when burn-out all fuel, water boiler temperature in tank has no influence to shutdown.

5.1 VIGAS BOILER CONTROL

5.1.1 Boiler activation

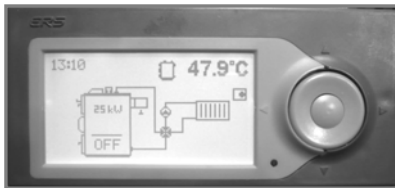

If boiler is in unactive status with symbol „OFF“, as displayed on the picture, by pressing the central button ENTER the boiler start the operation.

5.1.2 Boiler activated – heating mode



Boiler is set to heating mode, if outgoing gases temperature is lower, then set minimal gases temperature. Minimal gases temperature, as well as, maximal gases temperature can be set in boiler settings. Minimal gases temperature is set on 90°C, maximal gases temperature is on 200°C, which are standard settings. Pump is **pulse** working in dependence on temperature of the boiler water!

5.1.3 Boiler activated – burning mode

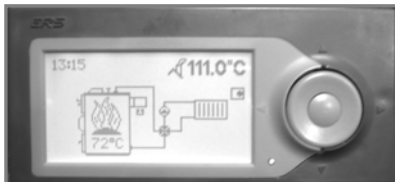

The burning mode is active after the gases temperature is higher (end) + 20°C. In this mode pump is working **pulse** (bolier protection against low-temperature corrosion). The pump is working, when symbol flash. Boiler is responsive to indoor thermostat, when indoor thermostat is switched off boiler slowly decreasing its output.

5.1.4 Adding fuel, Disconnection the boiler (manually)

Using graphical control. To call the graphical control, press central button ENTER. Graphical control offers option to switch off, adding fuel or cancel the graphical control.



Choose one option	
OFF	Switch off
	Add fuel
<input checked="" type="checkbox"/>	Cancel the control
▼ ▲	Change the indicated value

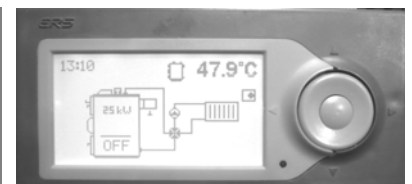

By pressing fan will be switched off. By using the rod open the chimney flap, consequently open the upper door. You can add fuel, if necessary. Close the upper door and chimney flap.

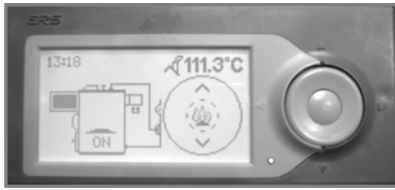

By pressing „“ adding fuel will be stopped. Fan will be switched on automatically.

5.1.5 Disconnection the boiler (Automatically)

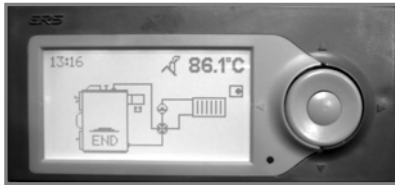

When gases temperature drops under the set temperature (end) boiler is switch-off automatically. „END“ will be indicated on the display. By pressing „ENTER“ boiler will start operating again.

6. VIGAS BOILER IN CONFIGURATION WITH GASES THERMOMETER AND DISCHARGE FAN (without lambda sensor)

Advantages of gases thermometer are described in Chapt.5. Main advantage of discharge fan is increased comfort during heating or adding fuel. When discharge fan is active during adding fuel there is significant decrease of smudging into boiler-room. During the heating, discharge fan will accelerate the burning.

6.1 VIGAS BOILER CONTROL

6.1.1 Boiler activation

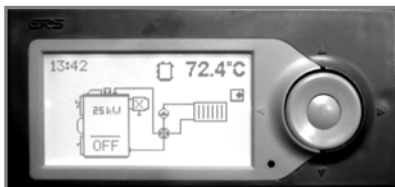

If boiler is in unactive status with symbol „OFF“, as displayed on the picture, by pressing the central button ENTER the boiler start the operation.



Choose one option	
+60	Discharge fan active for 60s. (Using when heating)
ON	Boiler activation
<input checked="" type="checkbox"/>	Cancel the control
▼▲	Change the indicated value

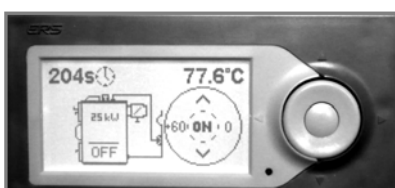

If „+60“ is chosen, new graphical control is indicated. In left corner is running time of discharge fan.	
+60	Another 60s. could be added. 300s. maximum
ON	Boiler activation
0	Discharge fan disconnection
▼▲	Change the indicated value

6.1.2 Boiler activated – heating mode

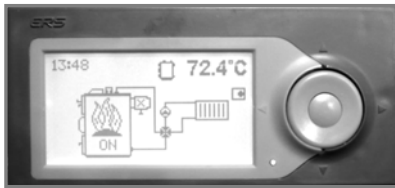

Boiler is set to heating mode, if outgoing gases temperature is lower, then set minimal gases temperature (📈 end). Minimal gases temperature, as well as, maximal gases temperature can be set in boiler settings. Minimal gases temperature is set on 90°C, maximal gases temperature is set on 200°C, which are standard settings. Pump is **pulse** working in dependence on temperature of the boiler water!

6.1.3 Boiler activated – burning mode

The burning mode is active after the gases temperature is higher (📈 end) + 20°C. In this mode pump is working **pulse** (boiler protection against low-temperature corrosion). The pump is working, when symbol flash. Boiler is responsive to indoor thermostat, when indoor thermostat is switched off boiler slowly decreasing its output.

6.1.4 Adding fuel, Disconnection the boiler (manually)

Using graphical control. To call the graphical control, press central button ENTER. Graphical control offers option to switch off, adding fuel or cancel the graphical control.



Choose one option	
OFF	Switch off
	Add fuel
<input checked="" type="checkbox"/>	Cancel the control
▼▲	Change the indicated value

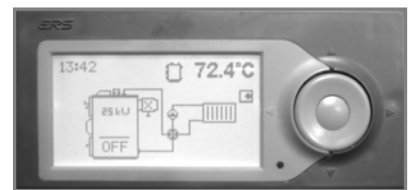

By pressing fan is switched off and discharge fan is automatically activated on 300s. In left corner is running time of discharge fan. If „+60“ is chosen, new graphical control is indicated. By using the rod open the chimney flap, consequently open the upper door. You can add fuel, if necessary. Close the upper door and chimney flap. By pressing „0“ discharge fan is switched off. By pressing adding fuel is finished, discharge fan is switched off automatically and fan will be switched on.

5.1.6 Disconnection the boiler (Automatically)



When gases temperature drops under the set temperature (📈 end) (boiler is switch-off automatically). „END“ will be indicated on the display. By pressing „ENTER“ boiler will start operating again.

7. VIGAS BOILER IN CONFIGURATION WITH Lambda Control (without discharge fan)

Advantages of gases thermometer are described above. VIGAS Lambda Control boiler is delivered with built-in gases thermometer. VIGAS Lambda Control boiler utilizes informations from lambda sensor of oxygen overflow in gases, to control the flap of primary and secondary air. This system allows to burn all kinds of wood more efficiently and at the same time decreasing the fuel consumption by 20-25%.

7.1 VIGAS Lambda Control BOILER CONTROL

7.1.1 Boiler activation

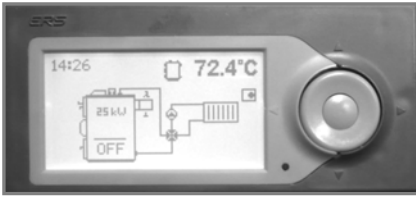

If boiler is in unactive status with symbol „OFF“, as displayed on the picture, by pressing the central button ENTER the boiler start the operation.

7.1.2 Boiler activated – heating mode

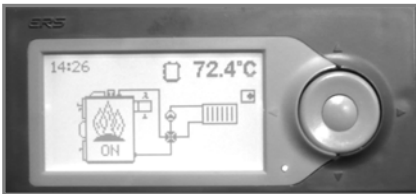

Servo-controlled flap will move to open position (servo 100%) when „ENTER“ button is pressed. Consequently, futher steps (from 100% up to 45%) is moved that, value of lambda sensor is kept close to set value (λ 1,35). In position (servo 45%) secondary air is closed, in position (servo 0%) also primary air is closed. To position 0% will be moved only if the boiler is „OFF“ or „END“. Boiler is set to heating mode, if outgoing gases temperature is lower, then set minimal gases temperature (↗ end). Minimal gases temperature, as well as, maximal gases temperature can be set in boiler settings. Minimal gases temperature is set on 90°C, maximal gases temperature is set on 200°C, which are standard settings. Pump is **pulse** working in dependence on temperature of the boiler water!

7.1.3 Boiler activated – burning mode



The burning mode is active after the gases tempeature is higher (↗ end) + 20°C. Servo-controlled flap wokrs in this mode as in heating mode. In this mode pump is working **pulse** (bolier protection against low-temperature corrosion). The pump is working, when symbol flash.

7.1.4 Adding fuel, Disconnection the boiler (manually)



Using graphical control. To call the graphical control, press central button ENTER. Graphical control offers option to switch off, adding fuel or cancel the graphical control.

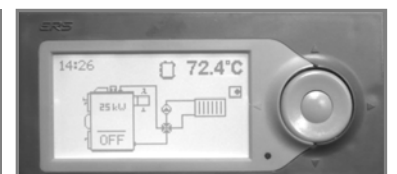

Choose one option	
OFF	Switch off
↗	Add fuel
☒	Cancell the control
▼▲	Change the indicated value





By pressing „“ fan is switched off. By using the rod open the chimney flap, consequently open the upper door. You can add fuel, if necessary. Close the upper door and chimney flap. By pressing „“ adding fuel will be stopped. Fan will be switched on automatically. During fuel adding, servo-controlled flap is in the same position as before fuel adding. When adding is finished, servo-controlled flap will be moved to position (servo 100%). Consequently, further steps (from 100% up to 45%) is moved that, value of lambda sensor is kept close to set value (λ 1,35). In position (servo 45%) secondary air is closed, in position (servo 0%) also primary air is closed. To position 0% will be moved only if the boiler is either „OFF“ , „END“ or switched-off fan.

7.1.5 Boiler disconnection (automatically)



When gases temperature drops under the set temperature ( end) (boiler is switch-off automatically). „END“ will be indicated on the display. Servo-controlled flap will be moved to position (servo 0%). In this position secondary air is closed as well as primary air. By pressing „ENTER“ boiler will start operating again.

8. VIGAS Lambda Control BOILER IN CONFIGURATION WITH GASES THERMOMETER AND DISCHARGE FAN

Advantages of gases thermometer and discharge fan are described above. VIGAS Lambda Control boiler utilizes informations from lambda sensor of oxygen overflow in gases, to control the flap of primary and secondary air. This system allows to burn all kinds of wood more efficiently and at the same time decreasing the fuel consumption by 20-25%.

8.1 VIGAS Lambda Control BOILER CONTROL

8.1.1 Boiler activation

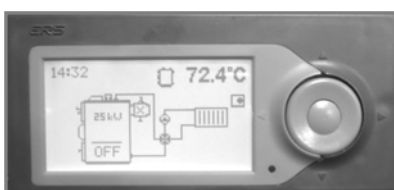

If boiler is in unactive status with symbol „OFF“, as displayed on the picture, by pressing the central button ENTER the graphical control will be called.



Choose one option	
+60	Discharge fan active for 60s. (Using when heating)
ON	Boiler activation
<input checked="" type="checkbox"/>	Cancel the control
▼ ▲	Change the indicated value



If „+60“ is chosen, new graphical control is indicated. In left corner is running time of discharge fan.	
+60	Another 60s. could be added. 300s. maximum
ON	Boiler activation
0	Discharge fan disconnection
▼ ▲	Change the indicated value

8.1.2 Boiler activated – heating mode



Servo-controlled flap will moves to open position (servo 100%) when „ON“ button is pressed. Consequently, futher steps (from 100% up to 45%) is moved that, value of lambda sensor is kept close to set value (λ 1,35). In position (servo 45%) secondary air is closed, in position (servo 0%) also primary air is closed. To position 0% will be moved only if the boiler is „OFF“ or „END“. Boiler is set to heating mode, if outgoing gases temperature is lower, then set minimal gases temperature (\curvearrowright end). Minimal gases temperature, as well as, maximal gases temperature can be set in boiler settings. Minimal gases temperature is set on 90°C, maximal gases temperature is set on 200°C, which are standard settings. Pump is **pulse** working in dependence on temperature of the boiler water!

8.1.3 Boiler activated – burning mode



The burning mode is active after the gases tempeature is higher (\curvearrowright end) + 20°C. Servo-controlled flap wokrs in this mode as in heating mode. In this mode pump is working **pulse** (bolier protection against low-temperature corrosion). The pump is working, when symbol flash.

8.1.4 Adding fuel, boiler disconnection (manually)

Using graphical control. To call the graphical control, press central button ENTER. Graphical control offers option to switch off, adding fuel or cancel the graphical control.



Choose on option	
OFF	Switch off
	Add fuel
<input checked="" type="checkbox"/>	Cancel the control
	Change the indicated value

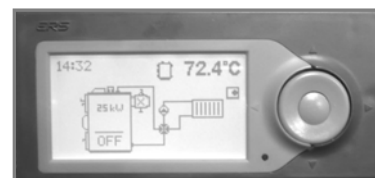

By pressing fan is swithed off and discharge fan is automaticaed on 300s. In left corner is running time of discharge fan. If „+60“ is chosen, new graphical control is indicated. By using the rod open the chimney flap, consequently open the upper door. You can add fuel, if necessary. Close the upper door and chimney flap. By pressing „0“ discharge fan is swithed off. By pressing adding fuel is finished, discharge fan is swithed off automatically and fan will swithed on. During fuel adding, servo-controlled flap is in the same position as before fuel adding. When adding is finished, servo-controlled flap will be moved to position (servo 100%). Consequently, futher steps (from 100% up to 45%) is moved that, value of lambda sensor is kept close to set value (λ 1,35). In position (servo 45%) secondary air is closed, in position (servo 0%) also primary air is closed. To position 0% will be moved only if the boiler is eighter „OFF“ , „END“ or swithed-off fan.

8.1.5 Boiler disconnection (automatically)

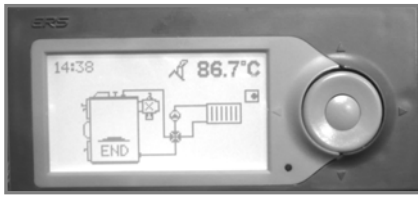

When gases temperature drops under the set temperature (end) (boiler is switch-off automatically). „END“ will be indicated on the display. Servo-controlled flap will be moved to position (servo 0%). In this position secondary air is closed as well as primary air. By pressing „ENTER“ boiler will start operating again.

8.2 PARAMETERS SETTING VIGAS Lambda Control BOILER AND VIGAS BOILER WITH GASES THERMOMETER



To call parameters setting hold „ENTER“ button at any boiler status and by pressing ▲ button.

„ENTER“



By ▲▼ buttons set the parameter you want to edit and by pressing „ENTER“ button, the value starts to flash. ▲▼ buttons set requested value.

max	Choose maximal gases temperature that will result in decreasing the operating speed
end	Choose shutdown temperature of the boiler
λ	Lambda value, that servo-controlled flap keeps. Recommended is 1,35.
„Δ⊙“	Increase or decrease the value, maximal output will be changed. Is advised to decrease the value in transition period (boiler tar level will drop).
*	Brightness
Roll	Press „yes“ will activate the value rolling (Pic.7/2)
Help 0s	Set the time when graphical control will be indicated

9. TIME SETTING

Set time and date, when boiler is plugged first time. In left corner is time is indicated.



To call parameters setting press longer „ENTER“ button at any boiler status and by pressing ▲ button twice.



By ◀ button set date or time, that will be edited. ▲▼ buttons choose date and time. Button ▶ will exit the settings.
 Mon – Monday, Tue – Tuesday, Wed – Wednesday, Thu – Thursday, Fri – Friday, Sat – Saturday, Sun – Sunday

10. HARDWARE AND SOFTWARE INFORMATION



To call informations setting hold „ENTER“ button at any boiler status and by pressing ▼ button.

▲▼ buttons choose modul and confirm „ENTER“. Information about the module will be indicated on display.



11. ERROR MESSAGES



To call error messages hold „ENTER“ button at any boiler status and by pressing ▼ 3 times. By pressing „ENTER“ error with description will be indicated on display.

11.1 STB failure



At „STB“ failure boiler is overheated. Thermal fuse is activated (Pic.3/21). The fan is disconnected from voltage. Boiler is activated again only if „STB“ protection is mechanical pressed. Boiler is need to be switch-on by „ENTER“ button.



12. SERVICE SETTINGS PIN 0000 PROTECTED



Service settings PIN 0000 protected can be used only in restricted cases. Only trained service engineer can do these settings. (In necessary cases client can do also). In service settings are adjusted boiler type with accessories and hydraulic connection scheme, etc.

To call the service setting PIN 0000 protected as follows:

1. Hold „ENTER“ button at any boiler status
2. Press ▲ button
3. Hold ◀ button for 4s - „PIN 0000“ will be indicated
4. Press „ENTER“ 4 times
5. Service settings symbol will be indicated on display
6. Press „ENTER“ and buttons ▲▼ choose service setting of boiler type, hydraulic connection scheme, micro SD card, service operation and press „ENTER“ .



12.1 Settings for micro SD card

AK 3000 control can be extended by SD modul (Pic.8). Micro SD card of different capacity is plugged into SD module.



Micro SD card allows:

- Loading of back-up software to control unit of the boiler
- Software back-up to SD card
- Loading of updated software from SD card to control unit of the boiler
- Selected parameters boiler back-up (f.e. boiler temperature, fan speed, lambda sensor value, etc.)
- SD card erasing



By pressing „ENTER“ symbols that micro SD cards allows will be indicated on the display. Buttons ▲▼ choose the task, you want to realize and then press „ENTER“.



12.2 Service settings boiler type with accessories



WARNING

Graphical control unit AK 3000 is used to control all types of VIGAS boilers. It is important, software settings must be same as type of the boiler. In deactivated boiler status „OFF“ boiler type is indicated on the display, that is equal to boiler nominal output. **For correct boiler operation, boiler type must match with boiler type marked on boiler label.**

In case of control unit exchange, always must be AK 3000 checked!!!

Continue Chapt.14

7. Press „ENTER“, display indicates :

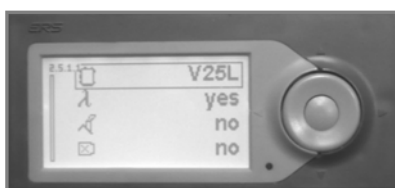

	Boiler type V- VIGAS, xx – nominal output, L – lambda TVZ – hot-air, UD – coal – wood, DP – wood – pellets
λ	yes – boiler with lambda sensor, no – boiler without lambda sensor
	yes – boiler with gases thermometer, no – boiler without gases thermometer
	yes – boiler with discharge fan, no – boiler without discharge fan

Boiler List	
V 16	V 80
V 16L	V 80L
V 25	V 100
V 25L	V 100L
V 40	V 25TVZ
V 40L	V 29UD
V 60	V 18DP
V 60L	

8. Buttons ▲▼ choose parameter and press ENTER

9. Button ► will exit the settings

12.3 Service settings hydraulic scheme connection

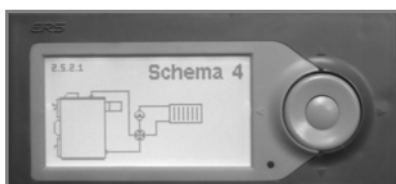
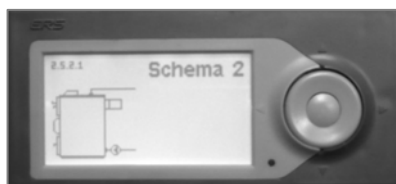

WARNING

The output control of the pump will be changed by hydraulic connection. It is important, that software setting of hydraulic pump match the setting of the boiler in connection with central heating system. Basic memory of control contains 4 schematics. It is possible to add more schematics if necessary. Schematics that are used for additional module „EXPANDER“ are delivered on mini SD card, or will be available on www.ers.sk , free to download, through PC to memory card that will be inserted to the module of the boiler control (Chapt.13).

If necessary, is it possible to return to last scheme to press „last“ Continue Chapt.14

7. Press „ENTER“, scheme 1 indicates on the display
8. Buttons ▲▼ choose requested scheme and press ENTER.
9. Button „ENTER“ confirm „Yes“ – to save scheme
10. To exit use ► button

Scheme 1 :

Scheme is dedicated for boiler with storage tank. „LADOMAT“ provides reverse water protection. Pump is connected to boiler control and working over 40 °C. Requested temperature is possible to set up to 90 °C. T3 contact on mother board AK 3000 S is used for connection to thermometer PT 1000, which is able to measure temperature in storage tank.

Warning: It is not possible to connect indoor thermostat to T3 contact.

Scheme 2 :

Scheme is dedicated to central heating systems, where reverse water protection provides external control system. Pump is connected to the control and it is working pulse in dependence of boiler water temperature. T3 contact on mother board is used to connect indoor thermostat.

Scheme 3 :

Scheme with 3-way thermostatic valve. Pump is connected to the control and it is working pulse in dependence of boiler water temperature. T3 contact on mother board is used to connect indoor thermostat.

Scheme 4 :

Scheme is set as a standard. Pump is connected to the control and it is working pulse in dependence of boiler water temperature. T3 contact on mother board is used to connect indoor thermostat.

12.4 Service tools



Functionality of each system can be checked in service settings by symbols indicated on display. Press „ENTER“ and selected system will be activated.

13. OPERATING INSTRUCTIONS

13.1 Before operation:

- to be informed with operating instructions and how to operate the electronic control AK 3000,
- to check the water pressure in the system of central heating (3 bars. max),
- to connect accessories (f.e. pump, discharge fan or indoor thermostat),
- to check the placing of fireclay bricks in combustion chamber pic.3,
- to check the cover metal sheets,
- to check the power to mains (230V/50Hz),
- to prepare sufficient amount of fuel for heating and burning.

13.2 Boiler operation

1. Connect boiler to distributing network (230V/50Hz) by power wire.
2. Wait when display will be activated to basic indication:
 - a) without lambda sensor – immediately,
 - b) with lambda sensor – 30 sec., approx. (automatical server initialization).
3. Chapt. 4 – 8 choose the configuration that match to your boiler configuration with accessories, that will help to control AK 3000.
4. Set the boiler with AK 3000 control to deactivated mode "**Off**".
5. Fuel heating:
 - a) by using the rod open the chimney flap (Pic.3/3),
 - b) open the upper door (Pic.3/2) on fireproof ceramics (Pic.3/9) put the paper so that small piece of paper extend to lower burning chamber (Pic.3/25), woodchips, cleft timber, and fill-up with fuel,
 - c) close upper door and open slightly lower (Pic.3/13) to start heating the fuel (obr.3/4), in configuration with discharge fan, the heating will be quicker to activated the fan.
 - d) close lower door and chimney flap when fuel is burning; 10 – 15 minutes, approx.,
6. Activate the boiler to „**ON**“. Boiler starts to gasifying and control its output automatically to set temperature.
7. To refill the fuel follow steps in chap. 4 – 8.
8. To deactivate the boiler, follow steps in chap. 4 – 8.

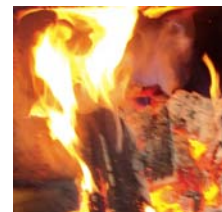

Burning fuel





Lower door open

13.3 Keeping operation and output regulation

Fuel in boiler is moved spontaneously in the direction to fireproof nozzle. Ash falls through nozzle and deposits in combustion chamber. Boiler output is regulated automatically according to the set temperature of outlet water. If there is mains failure during a longer period of time or if automatic regulation fails, it is possible to heat as follows (it is only applicable for the systems of central heating with gravitation flow): open chimney flap and let bottom door open a little. If this heating is used, it is necessary to check outlet temperature more frequently and to add less fuel. The boiler may easily become overheated if the whole fuel bunker is filled.

13.4 Refilling the fuel bunker with fuel

- open chimney flap with the help of operating rod (Pic.3/3),
- on graphical control press  (Available in Chapt. 4 – 8)
- open upper door with caution, to smoke venting
- refill necessary volume of fuel through upper door (Pic.3/2)
- close upper door (Pic.3/2) and chimney flap (Pic.3/3),
- button  will exit refuel



Wood	fuel efficiency [MJ/kg] at 20% humidity	fuel efficiency [MJ/kg] at 25% humidity	Hardness	weight [kg/m ³] at 25% humidity
Poplar	12,9	12,3	1	530
Fir	15,9	14,0	1	575
Spurce	15,3	13,1	1	575
Sallow	16,9	12,8	1	665
Pine	18,4	13,6	1	680
Alder	16,7	12,9	2	640
Birch	15	13,5	2	780
Maple	15	13,6	4	660
Beech	15,5	12,5	4	865
Ashen	15,7	12,7	4	865
Locust	16,3	12,7	4	930
Oak	15,9	13,2	4,5	840

[kg/m³]=[kg/plm], plm - pinometer, * (1 very soft...5 very hard)

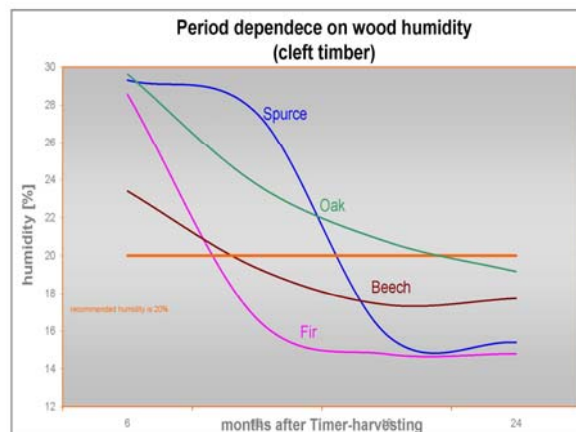

Important !!!

- Use correct fuel only
- **Is advised to not overload with fuel when operating the boiler in transition period, boiler tar level will drop.**
- When adding fuel, do not let it remain between flange and chimney flap, which might prevent flap to close properly.
- Lay fuel to boiler not to prevent upper door to close. Forcible closing may damage lining.
- We recommend to supervise boiler according to operation conditions by the person older than 18 years.

13.5 Boiler cleaning

If wood burning is optimal and minimum temperature of return water is kept, 60°C, gasification chamber, completing combustion space and exchanger are sooted minimally. If wet fuel is used, steam is condensed on the walls of combustion chamber and tar is created on surface.



Pic. VIGAS 60,80,100

▪ Gasification chamber cleaning

It is necessary to remove tar from gasification chamber once per week. We recommend to burn it with upper door and chimney flap open. With regard to the fact that inner walls of boiler have aluminium coating, we do not recommend to scrape tar off mechanically (it is only applicable for VIGAS 16, 25,40,UD29).

Excessive quantity of ash, that did not fall through nozzle (9) picture 3 into fireclay combustion

chamber, must be removed from time to time. Thus you will increase the space of fuel bunker

to original size and you will release the flow of primary air into gasification chamber. Check the continuity of openings for the intake of primary air on regular basis. If the openings are clogged, release them.

▪ **Combustion chamber cleaning**

Sweep ash and dust that fell to combustion chamber with a scraper. It is sufficient to sweep ash dust that settles in combustion chamber once per 3-5 days.

▪ **Exchanger cleaning**

It is necessary to clean exchanger pipes once per month with a "cleaning plate". Put cap away, (15) picture 3, and thus you will have an access to exchanger pipes.



Recommendation: If you do not clean the exchanger on time and it is too dirty, do not use any dissolvent for tar. Boiler must be clean while it is hot. Heat boiler through open chimney flap and upper door approx. at 80°C (without fan). Then close flap and door. Carefully (use gloves) open exchanger cap. Clean dirty exchanger with relevant accessories. After cleaning, close exchanger cap and let boiler burn / gasification/ approx 5 hours as maximum output in order the rest of tar might burn.

Warning: Boiler room must be properly ventilated during burning.

Step 1.



Step 2.



Step 3.



▪ **Air piping cleaning**

The clearness of boiler piping system is a necessary condition for right burning. If you mainly use sawdust, it is necessary to clean the piping system once per heating season. After putting fan cover (8) picture 3 and sheet cover of piping away, you will get access to two pipes. Use vacuum cleaner to remove sawdust and check continuity.

Step 1.



Step 2.



Step 3.

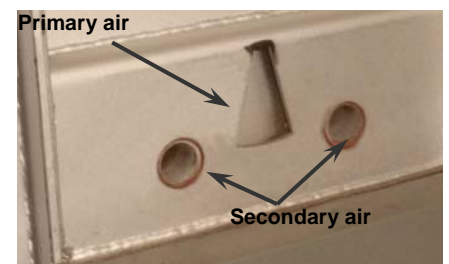
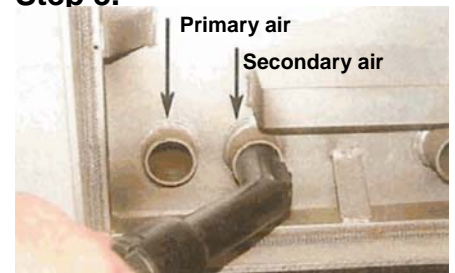

▪ VIGAS UD 29 cleaning

If you use brow coal, clean boiler as stated for wood. Clean fuel bunker with a cleaning flap (12) picture 3 and ashtray drawer (31) picture 3 as follows

1. Open bottom door (15) picture 5, stuff ashtray drawer and close door
2. Open cleaning flap and upper door (2) picture 5.
3. Use relevant accessories to pile up ash from fuel bunker space to drawer
4. Wait some time, open bottom door, take drawers and close it

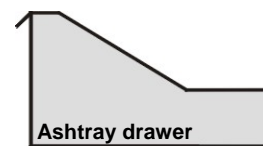

WARNING: Do not leave ashtray drawer in boiler during operation.

14. BOILER MAINTENANCE AND REPAIRS

The contractor ensures regular checks and boiler maintenance. During boiler operation, it is necessary to check water pressure, door tightness, chimney flap tightness, exchanger cap tightness, chimney tightness and fan performance.

NOTE: Before boiler shutting down during summer season, clean combustion chamber properly not to leave any condensed moisture there and open bottom door and chimney flap.

14.1 Door tightness:



Boiler door are stabilized in three points, on two revolving pins and on closing. If door does not fit tightly, besides revolving closing it is also possible to fix it from hinge side. You can slightly turn hinge bolt with releasing and turning nuts and thus you turn door in a desired direction. In case of sealing rope exchange "1" is a connecting point.

14.2 Chimney flap tightness:

When cleaning exchanger pipes (Pic. 3/24), check if flap closes tightly. Check chimney flap (Pic. 3/16) for the same as well. Leakage may result in decreased boiler output.

14.3 Heatproof nozzle



Heatproof nozzle is block made of heatproof concrete used to mix gases with secondary air and so efficient burning is in progress. Nozzle is located on water cooling rack. Nozzle is surrounded with heatproof concrete in the same height as nozzle. Nozzle lifetime depends from mechanical damage during fuel adding or poke the fire. Therefore, the nozzle is considered as spare part. Cracks on nozzle are not reason to nozzle exchange, this is necessary only when nozzle drops. If the nozzle is damaged, its necessary to remove bits and pieces of old nozzle and then insert new nozzle int the hole. Check if new nozzle fits in the hole.

14.4 Setting the position of servo VIGAS Lambda Control boiler

Correct setting of servo and flap for secondary air control is a key factor for burning with minimum emission. Servo and flap can be set in follows:



Step1: Disconnect power wire from distributing network 230V/50Hz,

Step2: Loose screw „1“ with fork wrench,

Step3: Turn the shaft with screwdriver „2“ to maximal position, anti-clockwise and push softly in direction to the boiler, shaft must be rotate easily!!!

Check the flap movement in hole „3“ ,

Step4: Draw close screw „1“

Step5: Connect power wire into distributing network 230V/50Hz. Automatical initialization, indicated on display, starts when power wire is connected into distributing network. During initialization servo will be pushed. When boiler is activated to „ON“ mode, flap will be moved to opposite position in anti-clockwise direction, where is controled eighter primary and secondary air to requested value λ .

14.5 Setting the position of secondary air flaps of VIGAS boiler



The quality of burning can be increased by secondary air flaps. VIGAS Lambda Control boilers regulate amount of secondary air automatically, therefore the quality of the burning is high. In VIGAS boilers withouth lambda sensor is adjusted with screws „1“. Optimal settings form production is adjusted to 2,5 turns „1“. When change or check the setting follow the steps:

Step1: „1“ loose the safety nut,

Step2: Draw close screw „1“ in direction to the boiler,

Step3: Loose the screw, back on 2,5 turns (optimum),

Step4: Draw close the safety nut.

Boiler without lambda sensor, safety flap is located above the fan „2“, that avert burning without fan (chimney draught). If boiler has lack of output , check flap functionality „2“.

TURN	FUEL
0	Not recommended
1	Wet wood
1,5	Wet softwood
2	Dry softwood
2,5	Dry hardwood
2,5 and more	Very dry, hardwood, small pieces

14.6 Lambda sensor and gases thermometer



Cleanness is important for correct functionality of lambda sensor and gases thermometer. Gently wipe dust from lambda sensor „1“ and gases thermometer „2“, when cleaning.

Important: Gases thermometer must be in correct position. Correct position of gases thermometer „2“ – end of the metal gases thermometer must be together with end-socket. (to change the position of the gases thermometer, indicated value will be changed significantly).

Disconnect („3“ and „4“) gases thermometer or lambda sensor if changed. If boiler does not contain terminals „3“ and „4“ disconnection must be realized directly from mother board AK 3000S.

15. ACCESSORIES ASSEMBLY

15.1 Drain valve

Usage of safety cooling exchanger:



Safety cooling exchanger together with drain valve, Honeywell TS 130, serves as boiler protection against overheating in case of power failure. If there is forced circulation, pump will be switched off and water circulation in the system of central heating stopped. If you have not ensured the automatic transition into gravitation (self-flowing) flow, or minimum heat consumption, 5 kW, boiler may be overheated.

Drain valve Honeywell TS 130, together with cooling exchanger are preventing to boiler overheating.

Assembly of drain valve TS 130:

On boiler socket "1" screw TS 130 valve on one of $\frac{3}{4}$ " boiler coupling so that **TS 130 might close water prior flowing to boiler**. Safety exchanger must be without water. The second coupling "3" will lead to canalization. Screw thermal sensor onto $\frac{1}{2}$ " "2".

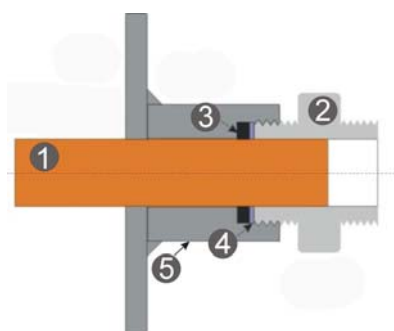

Warning:

- Assemble valve and thermal sensor prior filling the central heating system with water.
- Pressure of the cooling water can not be dependent on electrical voltage.
- Do not loose $\frac{3}{4}$ " socket „2“ when assembling, water leak possibility. Under the socket is aluminium ring „4“ with sealing „3“, that seals copper pipe „1“ in socket „5“.

If water leak, draw close $\frac{3}{4}$ " socket „2“.

Principle of operation:

Drain valve is regulated by hot water. If hot water temperature is 95°C , valve will open. Water running from water main absorbs temperature from boiler and thus it prevents overheating or boiler damage.

The system of boiler protection correspond with the standard, EN 303/5.

15.2 Discharge fan

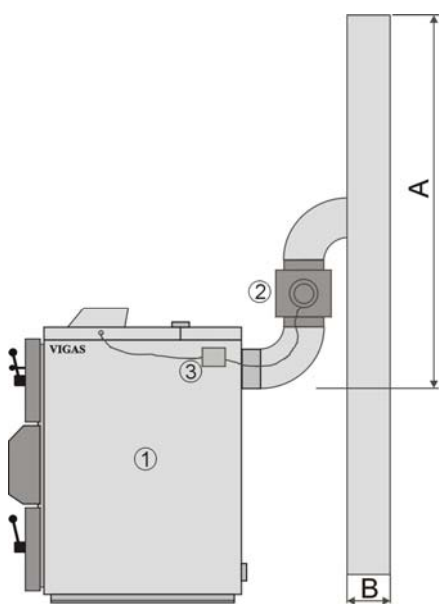

The discharge fan "2" is designed to discharge boiler waste gases from the gasification chamber during the adding of fuel into the log magazine. Its recommended to add discharge fan if you do not meet parameters „A“ and „B“.

Its mounted between chimney neck and chimney. Capacitor „3“ is mounted aboard of the boiler. Electrically connect to control board AK 3000S. Its supplied in two sizes in accordance of chimney neck.

V25 – for boilers VIGAS 16, VIGAS 25, VIGAS 29 UD

V80 – for boilers VIGAS 40, VIGAS 60, VIGAS 80, VIGAS 100

BOILER TYPE	Min A	Min B
VIGAS 16, VIGAS 25, VIGAS 29 UD	8 m	160 mm
VIGAS 40	8 m	200 mm
VIGAS 60, VIGAS 80, VIGAS 100	12 m	200 mm

Drawing with dimensions for V25 and V80 available on www.vimar.sk

15.3 Pump



AK 2000 electronic regulation, in its basic equipment, allows to connect one circulation pump. Pump control is depend on boiler water temperature and from selected scheme. Advantage is the pulse control of pump boiler protection against low-temperature corrosion. Its recommend, in connection with ladomat to set hydraulic scheme with storage tank, in acc. Chapt. 14.2

Breaker 0,8 A
Max. input 180 W

15.4 Indoor thermostat



Comfort is increased with indoor thermostat connection. Indoor thermostat is connected to mother board AK 3000S. Jumper is on T3 contact, standardly. Contact is switching, no voltage.

When T3 contact is disconnect, „OFF“ indicate on display. Fan will be disconnected. Boiler status is indicated by  symbol. After reclosure, boiler is in „ON“ mode and boiler is activated.

Warning:

If indoor thermostat is disconnected for longer than 1 hour, then boiler will be blown through for short time to keep glowing embers.

16. LIST OF GUARANTEE AND AFTER GUARANTEE SERVICES

In order quality and safe operation might be kept, repairs of boiler must be done by authorized specialists:

VIMAR Vigaš Pavel, Príboj 796, Slovenská Ľupča,

tel. 00421 48 41 87 022.

tel. 00421 48 41 87 159

mail: vimar@vimar.sk

See the current list of sale and service places:

www.vimar.sk , www.vigas.eu

17. PROBLEMS SOLVING

Problem	Cause/Solution
When heating with wood, boiler output is smaller that it was when it was new.	Clean ventilation system. Clean fan blades. Too wet fuel.
After closing chimney flap, fuel burns a little and then smokes.	Small volume of primary air. Clean primary ventilation system. Check if fan flap opens.
Bigger pieces of not burn out fuel are in combustion chamber.	Enlarged opening of nozzle. Change nozzle. Set secondary air to the position: 3 revolutions of flap back from the position of closing.
Smoke leaks through seal after closing door.	Fix . See door tightness. Take out and turn sealing. Change sealing.
It is not possible to open chimney flap.	Chimney flap is glued by tar. Increase boiler operation temperature. Use dry fuel. Increase boiler shutting down temperature
After opening upper door and chimney flap, boiler room becomes smoky.	Small chimney effect. Chimney diameter must be larger than the diameter of outlet chimney from boiler. See 15.2
Cracked fireproof /concrete/ lining.	No defect. Separates combustion chamber from gasification chamber.
Fan does not turn. It starts to turn after turning by hand..	Starting capacitor is defective. Change capacitor.
After the position "Heating" , boiler will shut down.	Incorrectly selected temperature of boiler shutting down. See the chapter „Configuration of boiler shutting down temperature“.
Boiler is shut down but fan still works.	Damaged cabling to fan.
Pump works and  does not signal pump operation	Neutral conductor is connected with earth conductor. Damaged cabling to pump.
Warning signals and signs	Cause/Solution
!!!STB!!!	See 11.1
Tmax	Display indicated Tmax if boiler overheat adjusted temperature by 0 3°C.

18. ASSEMBLY INSTRUCTION

Recommended schema of basic connection with AK 3000 regulation.

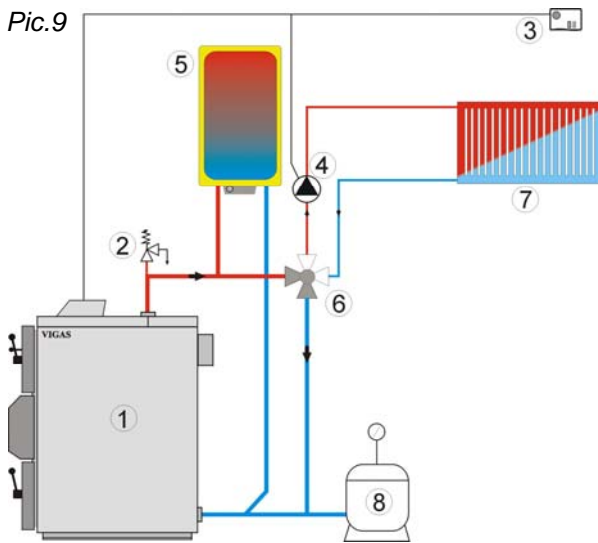

For connection, as shown on picture 9, boiler is delivered standardly. In case of need is possible to mount pump to boiler circuit. In such case, both boilers are connected together in terminal on AK 3000S. Sum of input power both pumps can not be higher than 150W.

1. VIGAS boiler
 2. Safety valve
 3. Indoor thermostat
 4. Circulation Pump
 5. Hot water storage tank
 6. Four-way blender
 7. Central heating circuit
 8. Exp. bin
 9. Storage tank
 10. Gases thermometer
- R- Distributer
Z- Collector

Pic.10

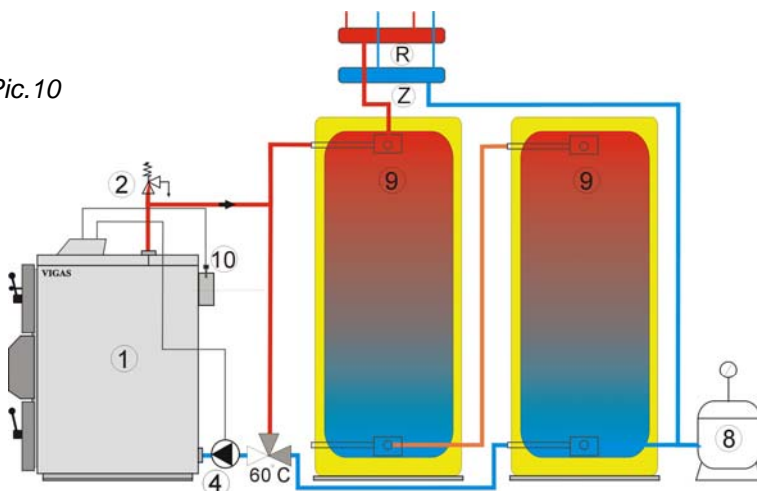

For connection, as shown on picture 10, its recommend to set graphical scheme on display in accordance chapt. 12.3.

See other schemes of connection and other possible regulations
www.vimar.sk.

18.1 Assembly and maintenance instructions

- Boiler can only be connected to the system of central heating whose thermal capacity correspond with boiler output.
- When forced circulation used and there is mains failure (boiler and pump stop to operate), the system of central heating must be adapted to ensure minimum boiler power take-off, 5 kW. This is provided with safety cooling exchanger with drain valve, Honeywell TS 130(Honeywell is not a component part of delivery, it should be ordered separately).
- Boiler must be connected correctly and as short as possible to chimney. Other appliances must not be connected to chimney. Chimney shaft must be dimensioned according to the standards: STN 734201 and STN 734210.
- We do not recommend permanent connection to water supply through feed water valve to avoid not allowed increase in pressure if valve is not tightly sealed. Maximum overpressure is 0,3 MPa.
- The room where boiler is placed must be ventilated properly.

- Boiler assembly must be done by specialists of assembly firms.
- Boiler need not be placed on a firm base.
- Minimum temperature of reversible water at boiler inlet is 60 °C.
- Boiler room must be ventilated permanently through the opening of min. diameter 0,025 m². The diameter for air inlet and outlet must equal approximately.
- Boiler must be installed in the surrounding that is common, basic in accordance with the standard, STN 33 2000-3.
- Work and health safety regulations must be followed in accordance with current instruction requirements, UBP SR No. 718/2002 Coll. and seq.
- Z hľadiska požiaro-technické vlastnosti hmôt v blízkosti kotla musia byť splnené požiadavky normy STN 73 0823:1983/z1 - Stupeň horľavosti stavebných hmôt.

18.2 Safety regulations for control and maintenance of VIGAS boiler electric equipment

The boiler operator must follow relevant regulations and standards, as well as the following principles:

- If boiler is in operation, none of the following may be done with electric equipment:
 - uncover electronic equipment, e.g. boiler electronics, fan, thermostat,
 - to exchange fuse,
 - to repair damaged cable insulation etc.
- Maintenance and repairs of boiler with uncovered electric equipment may only be done by persons authorized to do so according to 74/1996 Coll.
- Before uncovering boiler or any electric equipment connected to boiler, it is necessary to disconnect any mains /unplug/. You can only plug in after placing covers on original places.
- If there is any defect of electric equipment or boiler installation is damaged it is important: - do not touch any part of boiler
 - disconnect boiler from mains /unplug/.
 - to call an authorized service technician that will correct defect.

Apart from common maintenance of boiler, it is strictly forbidden:

- to manipulate electric equipment and boiler installation if plugged in,
- to touch damaged electric equipment and boiler installation, mainly damage cable insulation , etc.,
 - to operate boiler if uncovered,,
 - to operate boiler with defective electric equipment or defective boiler installation,
 - to repair damaged boiler electric parts by persons unauthorized by the producer

19. ELECTRIC SCHEME OF CONNECTION VIGAS BOILERS

Flow diagram of basic connection VIGAS AK 3000 boiler

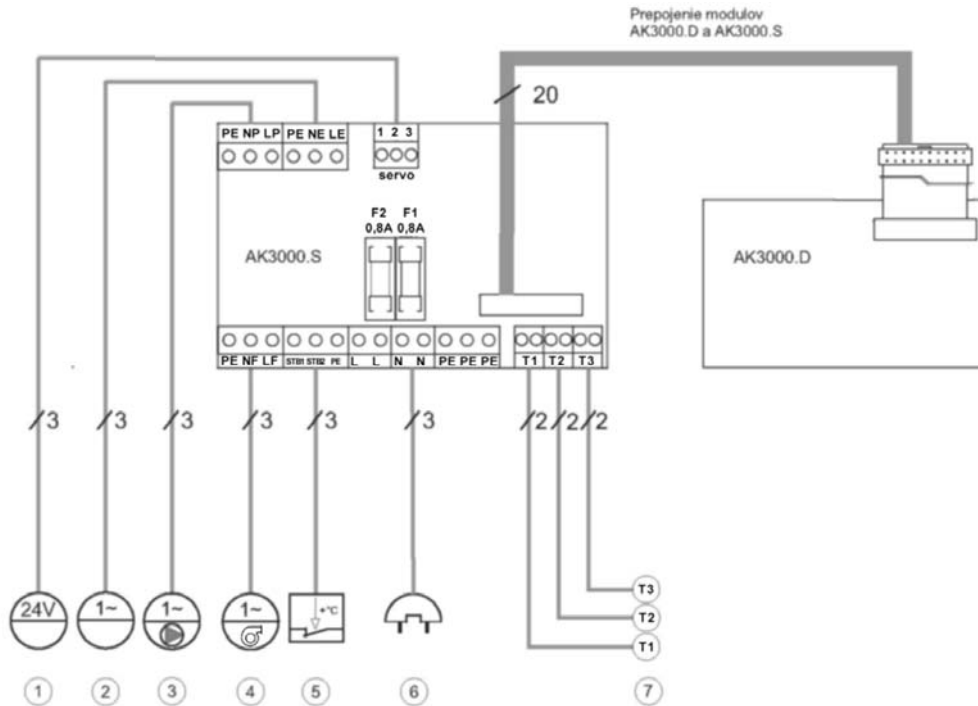

Flow diagram of basic connection VIGAS Lambda Control AK 3000.1 boiler

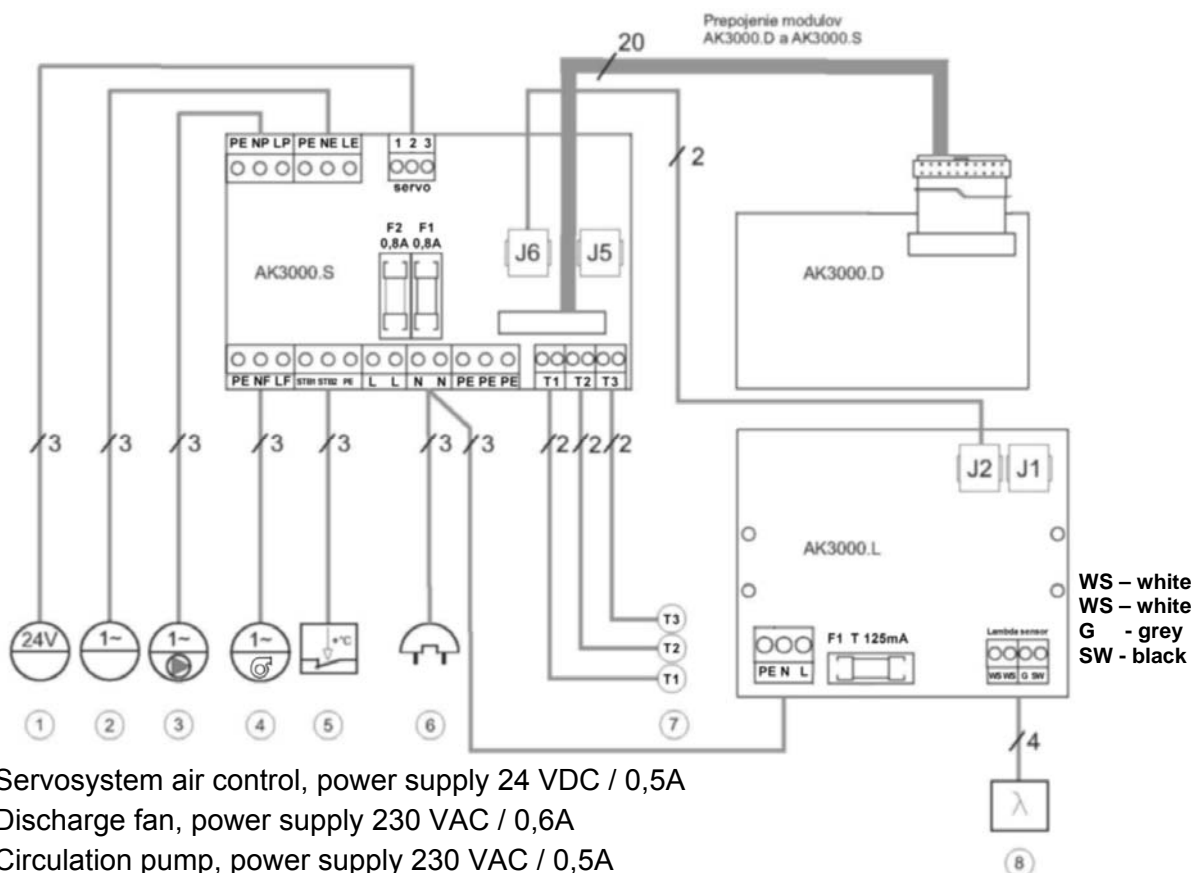

1. Servosystem air control, power supply 24 VDC / 0,5A
2. Discharge fan, power supply 230 VAC / 0,6A
3. Circulation pump, power supply 230 VAC / 0,5A
4. Fab, power supply 230 VAC / 0,3A
5. Emergency thermostat STB 100 °C
6. Power supply 230 VAC, 50 Hz
7. T1 Thermometer KTY, T2 Thermometer PT1000, T3 Indoor thermostat, no voltage, for hydraulic scheme 2,3,4. For hydraulic scheme 1 thermometer PT 1000.
8. Lambda sensor

LETTER OF GUARANTEE

Certificate of Quality and Completeness

Product

VIGAS **kW**

Serial number :

The producer confirms that the boiler comply with the standards, STN EN 303-5, STN EN 61010-1+A2:2000, STN EN 50081-1:1995, STN EN 50082-1:2002, STN EN 61000-3-3:2000, STN EN 61000-3-2:2000+A1+A2:2001.

Production inspection date

.....
Stamp a signature of producer

Date of sale

Date of commissioning:

.....
Stamp and signature of seller

Instructions for customers and guarantee conditions.

- Claims regarding the completeness of delivery must be in accordance with Commercial Code and Civil Code of the supplier,
- Damage and defects due to transport must be claimed by customers to a carrier when goods is taken over.
- Guarantee period is 24 month from the date of sale.
- Guarantee is valid if boiler is commissioned by an authorized serviceman.
- Guarantee is valid if all the electric equipment is connected to regulation by an trained specialist and if recorded in relevant documents..
- Guarantee applies to construction, used material and product manufacture.
- Transport of serviceman is not included into guarantee repair (it is paid by a customer in its full amount).

Guarantee does not apply to:

- consumer material: door seal, seal of exchanger cap, seal under fan, heatproof nozzle, heat proof / concrete/ filling, fireclay bricks,
- defects caused by a customer,
- defects due to not following assembly instructions, incorrect operation and maintenance or if the product is used otherwise than instructed and for a different purpose than specified in normal conditions; incorrect or unauthorized handling,
- otherwise the guarantee follows relevant provisions of Civil Code.

Confirmation of VGAS boiler commissioning

Product

VIGAS

kW

Production No. / Year of production

Date of sale

Date of commissioning

.....
Stamp and signature of producer

.....
Signature of serviceman

Name and adress of user:

When commissioning, we did the following:

- we informed the customer how to operate the boiler,
- we checked the boiler prior heating,
- we heated the boiler,
- we filled in and confirmed data of the Letter of Guarantee.

.....

Signature of the boiler user

Confirm and send to the producer !!

Records of electric equipment connection (pump, discharge fan, indoor thermostat, expander, etc.				
Date	Equipment	Name of serviceman	Certificate No.	Signature of serviceman
Records of guarantee and after guarantee repairs				
Date	Record od repair No.	Name of serviceman	Certificate No.	Signature of serviceman
Notes				



Serial number

VIMAR

Ecological and gasifying boiler

Producer:

VIMAR Vigaš Pavel
M. Culena 25
974 11 Banská Bystrica
SLOVENSKO

Production plant:

VIMAR Vigaš Pavel
Priboj 796
976 13 Slovenská Lupča
SLOVAKIA
tel.: 00421 48 4187 022
fax: 00421 48 4187 159

WWW.VIMAR.SK

vimar@vimar.sk